

SGL40N150D

General Description

Fairchild's Insulated Gate Bipolar Transistor (IGBT) provides low conduction and switching losses. The SGL40N150D is designed for induction heating applications.

Features

- High speed switching
- Low saturation voltage : $V_{CE(sat)} = 3.7 \text{ V @ } I_C = 40\text{A}$
- High input impedance
- Built-in fast recovery diode

Applications

Home appliances, induction heaters, IH JAR, and microwave ovens.

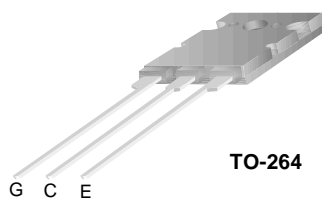

TO-264



Absolute Maximum Ratings $T_C = 25^\circ\text{C}$ unless otherwise noted

Symbol	Description	SGL40N150D	Units
V_{CES}	Collector-Emitter Voltage	1500	V
V_{GES}	Gate-Emitter Voltage	± 25	V
I_C	Collector Current @ $T_C = 25^\circ\text{C}$	40	A
	Collector Current @ $T_C = 100^\circ\text{C}$	20	A
$I_{CM(1)}$	Pulsed Collector Current	120	A
I_F	Diode Continuous Forward Current @ $T_C = 100^\circ\text{C}$	10	A
I_{FM}	Diode Maximum Forward Current	100	A
P_D	Maximum Power Dissipation @ $T_C = 25^\circ\text{C}$	200	W
	Maximum Power Dissipation @ $T_C = 100^\circ\text{C}$	80	W
T_J	Operating Junction Temperature	-55 to +150	$^\circ\text{C}$
T_{stg}	Storage Temperature Range	-55 to +150	$^\circ\text{C}$
T_L	Maximum Lead Temp. for Soldering Purposes, 1/8" from Case for 5 Seconds	300	$^\circ\text{C}$

Notes :

(1) Repetitive rating : Pulse width limited by max. junction temperature

Thermal Characteristics

Symbol	Parameter	Typ.	Max.	Units
$R_{\theta JC}$ (IGBT)	Thermal Resistance, Junction-to-Case	--	0.625	$^\circ\text{C/W}$
$R_{\theta JC}$ (DIODE)	Thermal Resistance, Junction-to-Case	--	0.83	$^\circ\text{C/W}$
$R_{\theta JA}$	Thermal Resistance, Junction-to-Ambient	--	25	$^\circ\text{C/W}$

Electrical Characteristics of the IGBT $T_C = 25^\circ\text{C}$ unless otherwise noted

Symbol	Parameter	Test Conditions	Min.	Typ.	Max.	Units
Off Characteristics						
BV_{CES}	Collector-Emitter Breakdown Voltage	$V_{GE} = 0V, I_C = 250\mu A$	1500	--	--	V
I_{CES}	Collector Cut-Off Current	$V_{CE} = V_{CES}, V_{GE} = 0V$	--	--	250	μA
I_{GES}	G-E Leakage Current	$V_{GE} = V_{GES}, V_{CE} = 0V$	--	--	± 100	nA

On Characteristics

$V_{GE(th)}$	G-E Threshold Voltage	$I_C = 40mA, V_{CE} = V_{GE}$	3.5	5.0	7.5	V
$V_{CE(sat)}$	Collector to Emitter Saturation Voltage	$I_C = 40A, V_{GE} = 15V$	--	3.7	4.7	V

Dynamic Characteristics

C_{ies}	Input Capacitance	$V_{CE} = 10V, V_{GE} = 0V,$ $f = 1MHz$	--	4000	--	pF
C_{oes}	Output Capacitance		--	700	--	pF
C_{res}	Reverse Transfer Capacitance		--	300	--	pF

Switching Characteristics

$t_{d(on)}$	Turn-On Delay Time	$V_{CC} = 600V, I_C = 40A,$ $R_G = 51\Omega, V_{GE} = 15V,$ Resistive Load, $T_C = 25^\circ\text{C}$	--	90	200	ns
t_r	Rise Time		--	230	700	ns
$t_{d(off)}$	Turn-Off Delay Time		--	245	400	ns
t_f	Fall Time		--	230	400	ns
Q_g	Total Gate Charge	$V_{CE} = 600V, I_C = 40A,$ $V_{GE} = 15V$	--	140	170	nC
Q_{ge}	Gate-Emitter Charge		--	25	25	nC
Q_{gc}	Gate-Collector Charge		--	45	60	nC

Electrical Characteristics of DIODE $T_C = 25^\circ\text{C}$ unless otherwise noted

Symbol	Parameter	Test Conditions	Min.	Typ.	Max.	Units
V_{FM}	Diode Forward Voltage	$I_F = 10A$	--	1.3	1.8	V
t_{rr}	Diode Reverse Recovery Time	$I_F = 10A, di/dt = 200A/\mu s$	--	170	300	ns

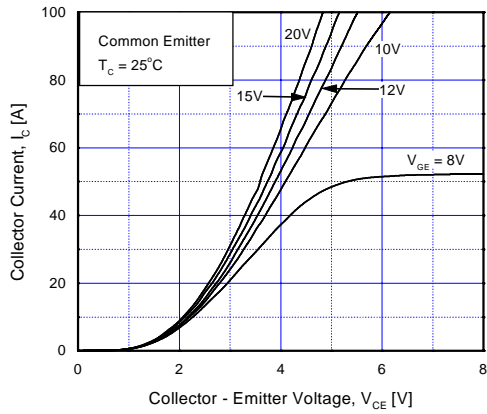

Fig 1. Typical Output Characteristics

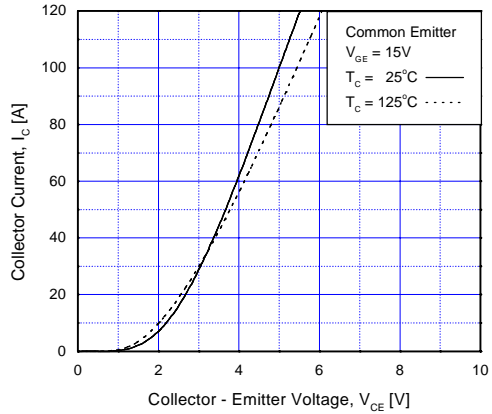

Fig 2. Typical Output Characteristics

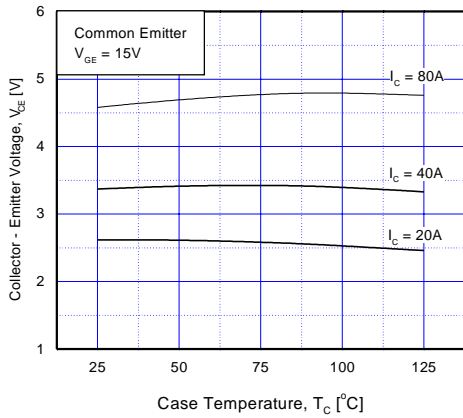

Fig 3. Collector to Emitter Saturation Voltage vs. Case Temperature

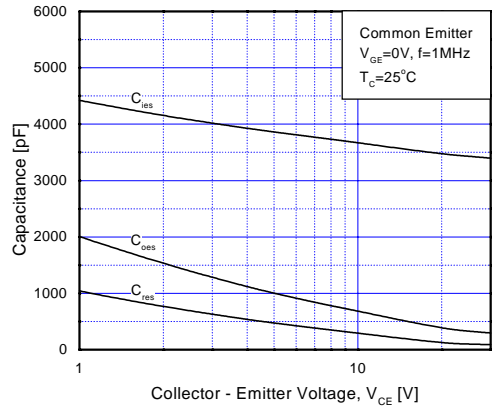

Fig 4. Typical Capacitance vs. Collector to Emitter Voltage

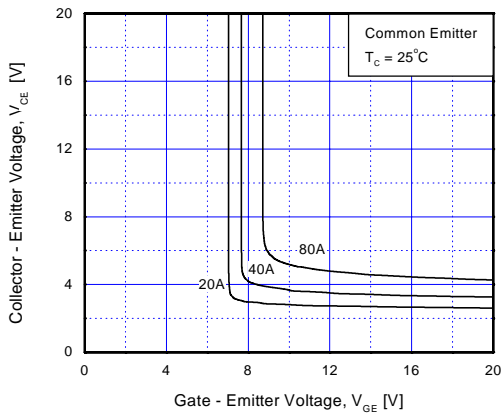

Fig 5. Saturation Voltage vs. V_{GE}

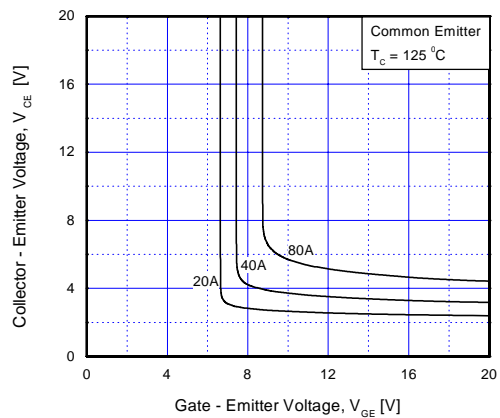

Fig 6. Saturation Voltage vs. V_{GE}

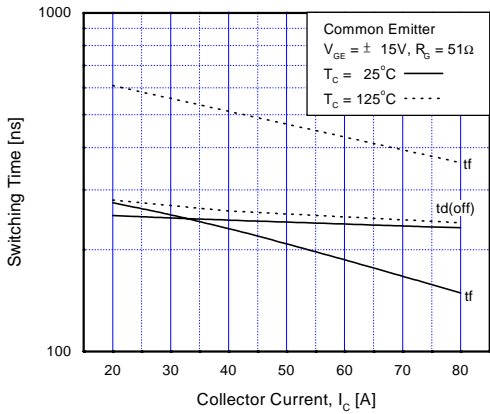

Fig 7. Turn-Off Characteristics vs. Collector Current

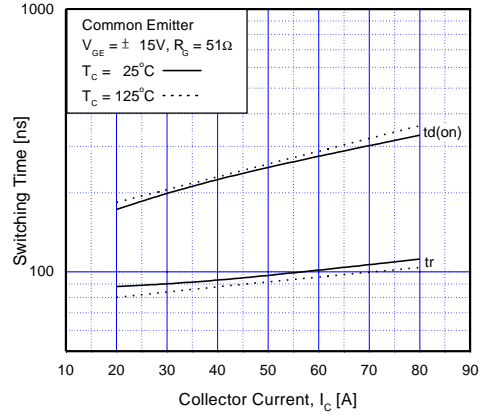

Fig 8. Turn-On Characteristics vs. Collector Current

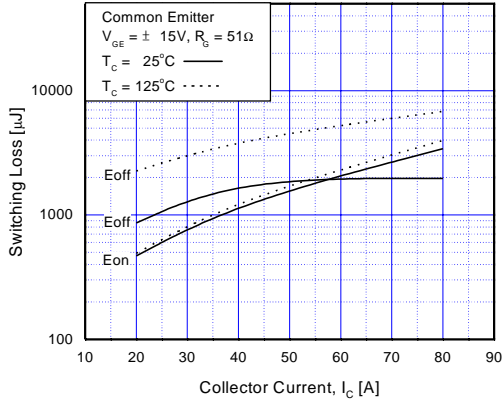

Fig 9. Switching Loss vs. Collector Current

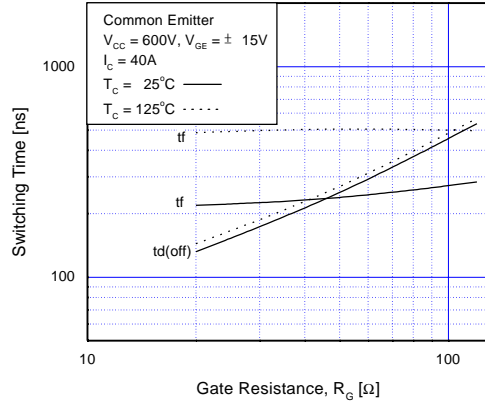

Fig 10. Turn-Off Characteristics vs. Gate Resistance

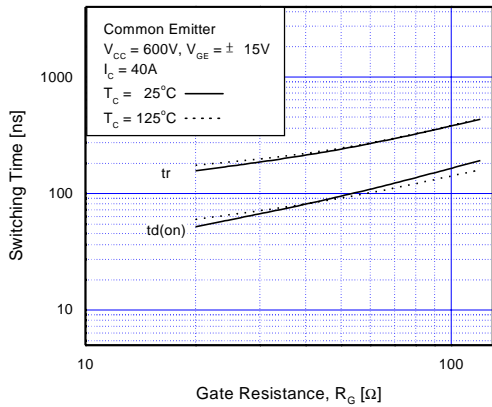

Fig 11. Turn-On Characteristics vs. Gate Resistance

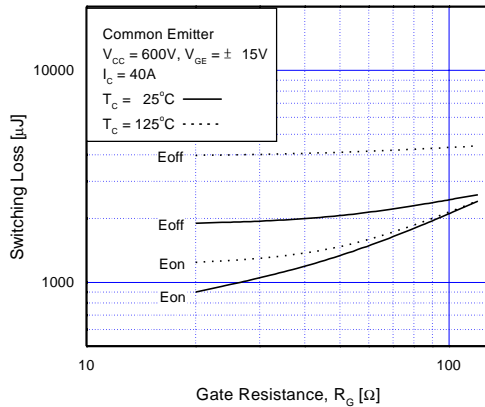

Fig 12. Switching Loss vs. Gate Resistance

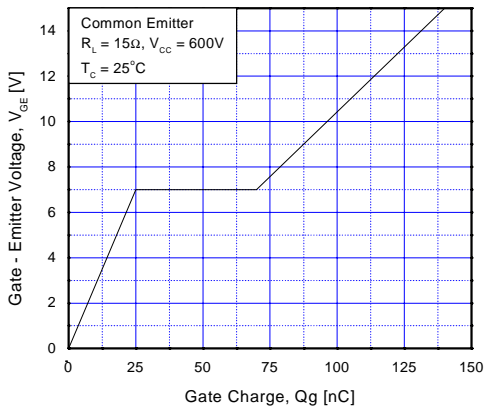

Fig 13. Gate Charge Characteristics

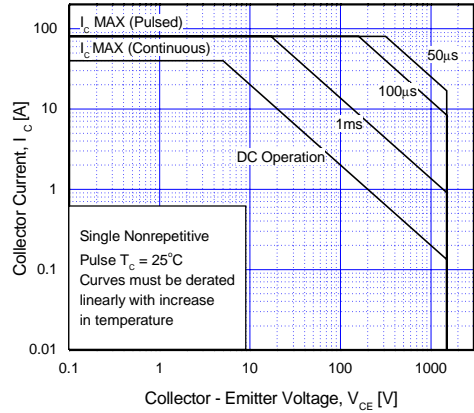

Fig 14. SOA Characteristics

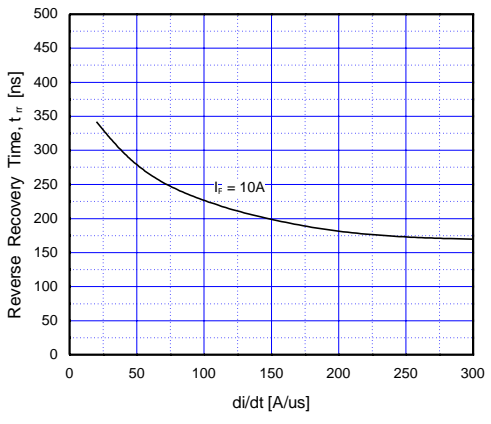

Fig 15. Typical T_{rr} vs. di/dt

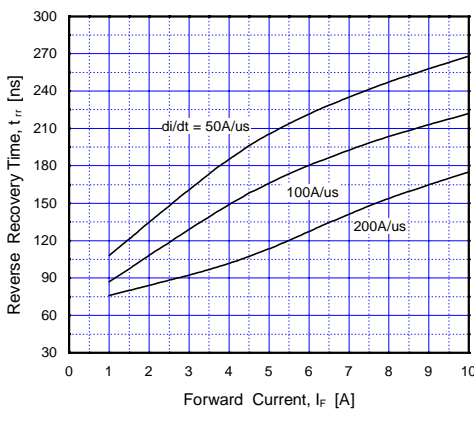

Fig 16. Typical T_{rr} vs. Forward Current

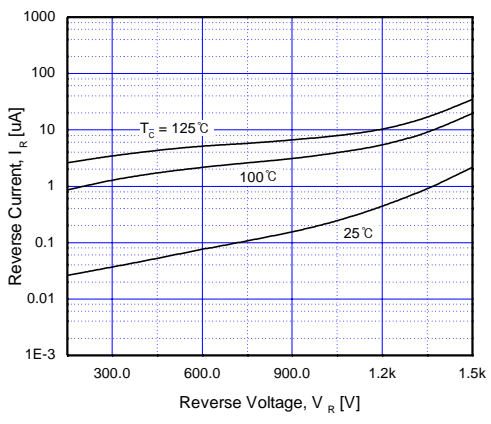

Fig 17. Reverse Current vs. Reverse Voltage

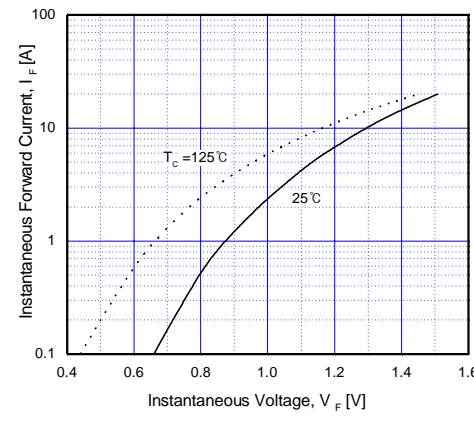

Fig 18. Typical Forward Voltage Drop vs. Forward Current

TRADEMARKS

The following are registered and unregistered trademarks Fairchild Semiconductor owns or is authorized to use and is not intended to be an exhaustive list of all such trademarks.

ACEx™	FAST®	MICROWIRE™	SLIENT SWITCHER®	UHC™
Bottomless™	FASTr™	OPTOLOGIC™	SMART START™	UltraFET®
CoolFET™	FRFET™	OPTOPLANAR™	SPM™	VCX™
CROSSVOLT™	GlobalOptoisolator™	PACMAN™	STAR*POWER™	
DenseTrench™	GTO™	POPT™	Stealth™	
DOME™	HiSeC™	Power247™	SuperSOT™-3	
EcoSPARK™	I ² C™	PowerTrench®	SuperSOT™-6	
E ² CMOS™	ISOPLANAR™	QFET™	SuperSOT™-8	
EnSigna™	LittleFET™	QS™	SyncFET™	
FACT™	MicroFET™	QT Optoelectronics™	TinyLogic™	
FACT Quiet Series™	MicroPak™	Quiet Series™	TruTranslation™	

STAR*POWER is used under license

DISCLAIMER

FAIRCHILD SEMICONDUCTOR RESERVES THE RIGHT TO MAKE CHANGES WITHOUT FURTHER NOTICE TO ANY PRODUCTS HEREIN TO IMPROVE RELIABILITY, FUNCTION OR DESIGN. FAIRCHILD DOES NOT ASSUME ANY LIABILITY ARISING OUT OF THE APPLICATION OR USE OF ANY PRODUCT OR CIRCUIT DESCRIBED HEREIN; NEITHER DOES IT CONVEY ANY LICENSE UNDER ITS PATENT RIGHTS, NOR THE RIGHTS OF OTHERS.

LIFE SUPPORT POLICY

FAIRCHILD'S PRODUCTS ARE NOT AUTHORIZED FOR USE AS CRITICAL COMPONENTS IN LIFE SUPPORT DEVICES OR SYSTEMS WITHOUT THE EXPRESS WRITTEN APPROVAL OF FAIRCHILD SEMICONDUCTOR CORPORATION.

As used herein:

1. Life support devices or systems are devices or systems which, (a) are intended for surgical implant into the body, or (b) support or sustain life, or (c) whose failure to perform when properly used in accordance with instructions for use provided in the labeling, can be reasonably expected to result in significant injury to the user.
2. A critical component is any component of a life support device or system whose failure to perform can be reasonably expected to cause the failure of the life support device or system, or to affect its safety or effectiveness.

PRODUCT STATUS DEFINITIONS

Definition of Terms

Datasheet Identification	Product Status	Definition
Advance Information	Formative or In Design	This datasheet contains the design specifications for product development. Specifications may change in any manner without notice.
Preliminary	First Production	This datasheet contains preliminary data, and supplementary data will be published at a later date. Fairchild Semiconductor reserves the right to make changes at any time without notice in order to improve design.
No Identification Needed	Full Production	This datasheet contains final specifications. Fairchild Semiconductor reserves the right to make changes at any time without notice in order to improve design.
Obsolete	Not In Production	This datasheet contains specifications on a product that has been discontinued by Fairchild semiconductor. The datasheet is printed for reference information only.